

Trendway®  Filing + Storage
July 2011 Price List
Choices®

Choices®

Choices is a fully featured product line that includes Filing and Storage Units.

Trendway product catalogs are available in the following design software: CAP, Data One, Giza, Midnight-Oil, and Project Matrix. The Systems price list is also available in .pdf (Acrobat Reader) format on www.trenddealer.com. For Architects and Designers, a free FSL (Furniture Symbol Library) is available on www.trendway.com.

Product dimensions are given throughout the product catalog and are followed by parenthesis which have the metric equivalent in millimeters. For example: A Rectangular Work Surface is available in a 48" (1219)-width.

Ordering Information

The most efficient way to enter an order is through Trendway On-Line Order Entry on www.trenddealer.com, which also accepts .sif files from the design software listed above. Faxed orders are available as well but may extend lead-times.

For ease in specifying, Trendway's catalog numbering system uses meaningful characters to convey description, surface type, and size. For example, PSLAT436 represents a Pack Four-High Lateral File that has 4 drawers and is 36" (914)-wide.

Order specification examples are shown throughout the price book at the bottom of each page. Be sure to follow the order sequence carefully to ensure complete and accurate order specification.

After placing an order, Trendway will send an order acknowledgement that follows the sequence of information outlined below. Trendway encourages you to follow the same steps so that checking your order against the acknowledgement will be as easy as possible.

Placing an Order

To make placing an order simple, Trendway On-Line Order Entry automatically prompts the product and option decisions that are required. For accurate order processing on faxed orders, please type or use legible handwriting, and be sure to include the following information:

1. A complete "sold to" address with correct Zip code.
2. A complete "ship to" address with correct Zip code.
3. A purchase order number. (The order is issued to Trendway Corporation, Holland, Michigan.)
4. A signature or name of person authorizing the purchase order.
5. A contact name and phone number at your company.
6. An actual calendar date for the requested delivery date (not ASAP).
7. Line items that are complete, which means all catalog numbers and descriptions, options listed for each product selected, fabric/finish pattern and color descriptions, and all corresponding letter or number codes. Be sure to make a pick for all available options. Also, combine identical items and specify total quantity unless using special marking or tagging.

(Refer to your price list for ordering options.)
8. Special products referenced by their control numbers as well as their descriptions.
9. Line items that include price per unit, as well as extended totals.
10. A total dollar amount for the purchase order.
11. Any special shipping requirements clearly noted; i.e., "call before delivery."

By placing your orders correctly and completely the first time around, your order will be processed and scheduled without delay (subject to credit approval).

Lead-Times

The majority of Pack and Choices products are shipped within Trendway's standard lead time. Extended lead-time items in the catalog are designated by shading. Express products ship three days after receipt of your order. Products and their options available for specification on Express are indicated with an **E** in front of the catalog number. Note that all chosen options for a product must also be available in the Express program to qualify.

Note: Shipping lead-times are subject to product availability due to order size. For exact lead-times on your order contact Trendway Customer Care.

Product Questions, Quotes & Order Placement On-Line

www.trenddealer.com
Hours: 24 Hours, 7 Days a Week

Customer Care Representative

Hours: Monday-Friday 7am to 6pm EST

Phone: 1-800-893-8115
Fax: 1-800-893-8121
e-mail: customer care@trendway.com

Trendway Custom Solutions

Phone: 1-800-893-8117

For more information on Order Placement, Confirmation, and Lead-Times, see the Pricing, Procedures & Policies section in the back of the price book.

Sequence Information

The table below shows a sample of the price book format's sequence of information which will assist when placing an order and checking an order acknowledgement.

	Catalog Number	Pull Style	Trim Color	Lock
Sample Part Number:	PSLAT436	.L	.J	.R

Surface Material Program

The Trendway Surface Material Program includes a broad selection of coordinated fabrics, laminate and trim finish options. Additionally, Trendway offers a Customers Own Material (COM) program to allow customers to further personalize their work stations.

The following sections describe the Trendway Surface Materials vocabulary.

Standard Program

Trendway's Standard Program of timeless fabrics, finishes, vinyls and laminates, is recommended for corporate standards programs. These fabrics are carded, swatched and stocked by Trendway.

Surface Trends

Trendway's Surface Trends Program is an evolving collection of fabrics, vinyls, and laminates, and are designated by  symbol. Influenced and kept up to date by emerging trends, the typical life span in this program is one to three years. Items no longer available through Trendway may still be available for purchase directly through the supplier. Materials in this program comply with, and in many cases exceed the industry standards for quality and performance.

Express

Express fabrics and finishes are available in a three-day lead time. Surface Materials available for specification on Express are indicated with a  in front of the 3-digit code.

Terratex®

Terratex is a True Textiles brand designating fabrics that are made from 100% recycled or compostable material using increasingly sustainable manufacturing practices to produce a high-quality product that is recyclable at the end of its useful life. For more information, go to www.terratex.com.

COM

Customers Own Material program allows customers to select and specify their own fabric or laminate on Trendway product. For detailed information, see COM in the Pricing, Procedures and Policies section in the back of the price book.

Pre-Approved COM

Select from popular COM fabrics pre-approved by Trendway. Customers are able to search the COM library on www.trenddealer.com for fabrics and specific applications that have passed manufacturability testing on Trendway product.

HOW TO ORDER SAMPLES

Binder Cards

Standard and Surface Trends binder cards are available through Trendway fulfillment. Call 1-800-968-5344, ext. 1.

Standard Program Samples

Samples of fabrics and finishes are available through Trendway fulfillment. Call 1-800-968-5344, ext. 1.

Surface Trends Samples

Surface Trends **samples must be ordered directly through the supplier.** Contact information is listed below. Reference the pattern name and color along with the supplier part number on the back of your binder card to order samples.

Guilford Of Maine®

www.guilfordofmaine.com/samplecenter
1-800-544-0200

Momentum® Textiles

www.memosamples.com
1-800-366-6839

CF Stinson®

www.cfstinson.com
1-800-841-6279

Wilsonart®

www.wilsonart.com
1-800-433-3222

Please note: Colors on printed sample cards are as accurate as offset printing allows. Please refer to the actual sample before ordering.

Surface Material Legend

 = 100% Recycled Content



Terratex brand is a registered trademark of Interface Fabric Group. Refer to your binder card to identify Terratex 100% recycled fabrics, or for a complete list www.trenddealer.com.



= Surface Trends Program (Samples available through supplier, refer to page 2 for a list of supplier contacts)

Standard Systems Finishes

Trendway standard paints include smooth and textured styles in our six trim colors.

Systems Paints and Trim

ⓔ G	Gray	ⓔ P	Pebble
ⓔ TG	Textured Gray	ⓔ TP	Textured Pebble
ⓔ J	Stucco	ⓔ Y	Sand
ⓔ TJ	Textured Stucco	ⓔ TY	Textured Sand
ⓔ K	Charcoal	ⓔ L	Light Gray
ⓔ TK	Textured Charcoal	ⓔ TL	Textured Light Gray

Edge Detail

Vinyl Edge Band

ⓔ G	Gray
ⓔ J	Stucco
ⓔ K	Charcoal
ⓔ L	Light Gray
ⓔ P	Pebble
ⓔ Y	Sand
E 1	Designer White
E 2	Slate Grey

Wood Grain Vinyl Edge Band

ⓔ W3	Fonthill Pear
W4	Chocolate Pear
W5	Fusion Maple
W6	Wild Cherry
W7	Empire Mahogany

Wood Grain Vinyl Edge Band, cont.

W8	Beigewood
W9	New Age Oak
WC	Windswept
WE	Brazilwood
WG	Woodlawn Cherry

Note: Wood Grain Vinyl Edge Band only available on lateral file tops.

Premium Systems Finishes

Premium finishes are offered at a modest upcharge. Please refer to a specific item in your price book to determine the amount of upcharge. Textured metallic colors display a matte texture with metallic highlights. They coordinate with standard Trendway trim colors (indicated by the second letter in the code).

Textured Metallic Paint

ⓔ FG	Gray Frost
ⓔ FJ	Stucco Frost
ⓔ FK	Charcoal Frost
ⓔ FP	Pebble Frost
ⓔ FY	Sand Frost
ⓔ FL	Light Gray Frost

Smooth Metallic

ⓔ X	Metallic Silver
-----	-----------------

High Pressure Laminates

Standard Program

Solid

 Wilsonart	
ⓔ 520	Gray
ⓔ 573	Light Gray
ⓔ 583	Charcoal
ⓔ J11	Stucco
ⓔ J20	Sand
J08	Slate Gray
J0C	Design White

Pattern

551	Stipple Graphite
553	Stipple Gray
JL6	Green Tigris
JM4	Evening Tigris
ⓔ JN2	Grey Tigris
ⓔ J09	White Tigris
ⓔ JP9	Natural Tigris
J19	Windswept

Wood Grain

ⓔ J28	Fonhill Pear
ⓔ J25	Fusion Maple
J0G	Beigewood
J1J	New Age Oak
ⓔ J1K	Cherry (Sheen Cherry)
J1M	Brighton Walnut 38
J2A	Empire Mahogany 38
J0A	Chocolate Pear
J0E	Woodlawn Cherry
J0D	Brazilwood
J1R	Wild Cherry

Surface Trends Program

Solid

 Wilsonart	
J04	Shadow

Pattern

 Wilsonart	
J12	Silicon Evolv
J13	Titanium Evolv
J14	Nickel Evolv
J15	Carbon Evolv
J16	Tungsten Evolv
J17	Windswept Bronze
J18	Windswept Pewter
J32	Pewter Brush
J33	Antique Brush
ⓔ J1A	Canyon Zephyr
ⓔ J1B	Misted Zephyr
ⓔ J1C	Loden Zephyr
ⓔ J1D	Desert Zephyr
J1E	Twilight Zephyr
J1F	Mission Stucco
J1G	Mission Sand
J1H	Mission Smoke
ⓔ J1N	Navy Legacy
J1P	Cloud Nebula

Pattern

 Nevamar	
J3U	Easy Elegance
J3V	Calm Distinction
J3W	Cool Chic
J3X	Vidrio Opaco
J3Y	Vidrio Aged
J40	VOUS Fawn
J41	VOUS Poire
J42	VOUS Serene
J43	VOUS Metal
J44	VOUS Tempest

Wood Grain

 Nevamar	
J45	Illustrious Maple
J47	Legendary Teak
J48	Luminary Teak
J49	Recon Oak

Pattern

 Pionite	
J3B	Taupe Serenity
J3E	Vanilla Fiber
J3F	Wheat Fiber
J3G	Negotiating in Geneva
J3H	Cavalcade South
J3J	Travelin Light
J3K	Gold Pannin
J3M	Cubicle Papel
J3N	Olive Serenity
J3P	Groundswell
J3R	Passin Thru

Wood Grain

 Pionite	
J3T	Spice Walnut
J39	Looks Likatre
J3A	Leave Likatre
J3C	Seems Likatre
J3D	Appears Likatre

Seating Fabrics

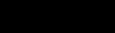
Basis  Grade A	
# Momentum	
B00	Amber
B01	Amethyst
B02	Colonial
B03	Fog
B04	Garnet
B05	Indigo
B06	Mallard
B07	Onyx
B08	River
B09	Ruby
B0A	Stone
B0B	Twig
B0C	Vine

Highbeam  Grade A	
# Guilford of Maine	
Ⓢ BC1	Buttercup
Ⓢ BC2	Black
Ⓢ BC3	Navy
Ⓢ BC4	Bayberry
Ⓢ BC5	Kiwi
Ⓢ BBN	Nude
Ⓢ BBP	Gold Rush
Ⓢ BBR	Barley
Ⓢ BBT	Rust
Ⓢ BBU	Espresso
Ⓢ BBV	Maroon
Ⓢ BBW	Tangerine
Ⓢ BBX	Slate
Ⓢ BBY	Grape

Hue  Grade A	
# Momentum	
AJ8	Black
AJ9	Dandelion
AK1	Frothe
AK2	Annato
AK3	Pacific
AK4	Eggplant
AK5	Sky
AK6	Night
AK7	Cocoa
AK8	Golden
B54	Aspen
B55	Currant
B56	Fern
B57	Indigo
BB4	Char
BB5	Chipotle
BB6	Laurel
BB7	Paprika
GHK	Latte

Moda  Grade A	
# Momentum	
BHT	Agave
BHU	Anthem
BHV	Derby
BHW	Medal
BHX	Onyx
BHY	Shiraz
BJ0	Tobasco

Open House  Grade A	
# Guilford of Maine	
Ⓢ A63	Red Delicious
Ⓢ A64	Onyx
Ⓢ A65	Pumpkin
Ⓢ A66	Pine Needle
Ⓢ A67	Midnight
Ⓢ A68	Willow
Ⓢ A69	Aubergine
Ⓢ A70	Mulberry
Ⓢ A71	Cumin
Ⓢ A72	Deep Water
Ⓢ A74	Thistle
Ⓢ A75	Goldenrod
Ⓢ A76	Fossil
Ⓢ B5A	Coffee Bean
Ⓢ B5B	Green Olive
Ⓢ B5C	Henna
Ⓢ B5D	Poppy
Ⓢ B5E	Straw
Ⓢ B5F	Amber
Ⓢ BE1	Angora
Ⓢ BEH	Asteroid
Ⓢ BE4	Cobalt
Ⓢ BE3	Geranium
Ⓢ BEG	Goose
Ⓢ BE9	Graphite
Ⓢ BE7	Green Apple
Ⓢ BE5	Lapis
Ⓢ BEE	Quarry Blue
Ⓢ BE8	Wolf

Perk  Grade A	
# Momentum	
B22	Auburn
B23	Cabana
B24	Cedar
B25	Crimson
B26	Dijon
B27	Ebony
B28	Flint
B29	Patriot
B2A	Pewter
B2B	Regal
B2C	Sesame
B2D	Walnut

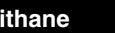
Woodford Polyurithane  Grade A	
# Morbern	
BK0	Black
BK1	Blueberry
BK2	Bone
BK3	Bright White
BK4	Burgundy
BK5	Charcoal
BK6	Chestnut
BK7	Dark Brown
BK8	Doe
BK9	Espresso
BKA	Hopfen
BKC	Hunter Green
BKD	Light Grey
BKE	Parchment
BKF	Saddle
BKG	Tan

Ace  Grade B	
# Momentum	
BFT	Bisque
BFU	Cadet
BFV	Calico
BFW	Carbon
BFX	Dark
BFY	Dream
BG0	Engine
BG1	Hot
BG2	Pesto
BG3	Regal
BG4	Scarlet
BG5	Trail
BG6	Tuxedo

Aurora  Grade B	
# Victor	
BJG	Starfire
BJH	Eos
BJJ	Dawn
BJK	Polar
BJM	Southern Lights
BJN	Eclipse
BJP	Moon dust
BJR	Atmosphere
BJT	Night Sky
BJU	Solarwind
BJV	Borealis
BJW	Horizon
BJX	Northern Lights

Axis  Grade B	
# Momentum	
Note: Not available on Live II Chairs.	
BGY	Denim
BH0	Grove
BH1	Noir
BH2	Paprika
BH5	Summer
BH3	Truffle
BH4	Willow

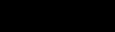
Cinch  Grade B	
# Momentum	
BGE	Aristocrat
BGF	Black
BGG	Camel
BGH	Cool
BGJ	Eco
BGK	Honest
BGM	Navy
BGN	Par
BGP	Root
BGR	Silver
BGT	Snap
BGU	Totem
BGV	Zeal

Fabric patterns noted with Ⓢ are available in Trendway's Express program.

Seating Fabrics

Cobble Grade B

 Guilford of Maine	
Ⓢ BDP	Citrine
Ⓢ BDT	Garnet
Ⓢ BDM	Gravel
Ⓢ BDU	Jade
Ⓢ BDY	Lapis
Ⓢ BE0	Onyx
Ⓢ BDR	Peridot
Ⓢ BDV	Ruby
Ⓢ BDN	Slate
Ⓢ BDX	Topaz
Ⓢ BDW	Turquoise

Era Grade B

 Momentum	
B11	Basil
B12	Cadet
B13	Char
B14	Chili
B15	Concord
B16	Ink
B17	Lemon
B18	Lime
B19	Merlot
B1A	Persimmon
B1B	Pine
B1C	Sterling
B1D	Stone

Gauge Grade B

 Momentum	
BHA	Admiral
BHC	Adrift
BHD	Alumina
BHE	Bronze
BHF	Cardinal
BHG	Chinos
BHH	Cocoa
BHJ	Decaf
BHK	Offshore
BHM	Oxide
BHN	Pesto
BHP	Plum
BHR	Sizzle

Interval Grade B

 Momentum	
Note: Not available on Live II Chairs.	
B1E	Aubergine
B1F	Autumn
B1G	Graphite
B1H	River
B1J	Sunset
B1K	Taupe
B1M	Thyme

Laredo Vinyl Grade B

 CF Stinson	
B62	Mosstone
B63	Berry
B64	Brandy
B65	Taupe
B66	Cinnabar
B67	Niagra
B68	Blue Moon
B69	Antique
B6A	Chocolate
B6B	Meritage
B6C	Hunter
B6D	Copen
B6E	Dill
B6F	Onyx
B6G	Deep Navy
B6H	Grape
BAE	Summer*
BAF	Blazer*
BAG	Norse*
BAH	Aspen*
BAJ	Biscotti*
BAK	Snow Cap*
BAM	Apricot*
BAN	Gelato*
BAP	Pelican*
BAR	Pumice*
BAT	Flint*
BAU	Camel*
BAV	Ceylon*
BAW	Quarry*
BAX	Mohave*
BAY	Brindle*
BB0	Honey*
BB1	Tan*
BB2	Shale*

*Colors not shown on swatch card but available from CF Stinson

Sockhop Grade B

 Guilford of Maine	
Ⓢ A86	Graphite
Ⓢ A87	Cobalt
Ⓢ A88	Twilight
Ⓢ A89	Pine
Ⓢ A91	Silver Lining
Ⓢ A92	Platinum
Ⓢ A93	Custard
Ⓢ A95	Bronze
Ⓢ A96	Pumpkin
Ⓢ A97	Garnet
Ⓢ BEK	Blue Moon

Eurosoft Leather Grade Leather

Note: Available only on Sketch M and R series, and Code chairs.			
L25	Teal	L4G	Burgundy
L28	Nuts	L4H	Parchment
L38	Ruby	L4J	Light Gray
L42	Black	L4K	Dark Brown
L45	Charcoal	L4M	Blueberry
L50	Saddle	L4N	Hunter
L4A	Blue	L4P	Bone
L4B	Espresso		
L4C	Moss		
L4E	Bright White		
L4F	Doe		

Moguls Grade B

 Guilford of Maine	
Ⓢ BCF	Coffee Bean
Ⓢ BCE	Flare
Ⓢ BCN	Grape Jelly
Ⓢ BC9	Graphite
Ⓢ BCJ	Honey Comb
Ⓢ BCM	Navy
Ⓢ BCK	Onyx
Ⓢ BCA	Rhododendron
Ⓢ BCC	Sand
Ⓢ BCH	Thistle

Trek Grade B

 Momentum	
BJ8	Chariot
BJ9	Éclair
BJA	Granite
BJC	Hedge
BJD	Rain
BJE	Ruby
BJF	Sunset

Impact Grade C

 Momentum	
BA1	Brazen
BA2	Chocolate
BA3	Crimson
BA4	Eggplant
BA5	Grotto
BA6	Indigo
BA7	Putty
BA8	Relic
BA9	Serene
BAA	Sesame
BAC	Sprout
BAD	Stark

Matrix Vinyl Grade D

 CF Stinson	
B5G	Spa
B5H	Mirage
B5J	Sorbet
B5K	Mango
B5M	Daybreak
B5N	Alpine
B5P	Willow
B5R	Passion
B5T	Mystic
B5U	Teak
B5V	Pinot
B5W	Galaxy
B5X	Phantom

Choices Filing & Storage

<u>Features & Planning</u>	8
<u>Choices Storage Towers</u>	9
<u>Choices Lateral Files & Lateral File with Storage Cabinet</u>	10
<u>Choices Double Door Storage & Wardrobe Units</u>	12
<u>Choices Double Door & Wardrobe Accessories</u>	13
<u>Choices File Centers</u>	14
<u>Choices Lateral File Tops</u>	15
<u>Choices Lateral File Accessories</u>	16
<u>Choices Pedestals</u>	17
<u>Choices Pedestal & File Center Accessories</u>	19
<u>Pencil & Center Drawers</u>	20
<u>Bookcases</u>	21
<u>Bookcase Accessories</u>	22

Finishes

All Trendway filing and storage units are painted metal. Choices Accent Strips are available in standard smooth finishes only.

Specifications

All dimensions are nominal unless otherwise noted.

Load Capacities

Center Drawers:

Center Drawer — 9 lbs. (4.1kg)

Total load capacities of hanging work surfaces are equal to the sum of the fully loaded components attached to the underside of the work surface plus the loads placed on the top of the work surface.

Pedestal Drawers:

6" (152) Pedestal Drawer — 20 lbs. (9kg)

12" (305) Pedestal Drawer — 40 lbs. (18kg)

Lateral File and Pedestal Lateral File Drawers:

2 lbs. (.9kg) per linear inch of usable space.

Stationary Shelves – Bookcases, Double Door Storage Units, Storage Towers

3 lbs. (1.4kg) per linear inch.

Maximum Load Capacity For Any Storage Unit

The maximum load capacity for any storage unit is calculated by multiplying the above stated lbs. per linear inch per each shelf or drawer that is included with the unit and adding them together (includes the top of the unit and the inside bottom).

Eg: Maximum load capacity for a BCB336
 = unit bottom + 2 shelves + unit top
 at 3 lbs. per linear inch
 = 36" (914) linear in. per shelf x 3 lbs. x 4
 = 432 lbs. maximum load

Note: The addition of more shelves **does not** increase the maximum amount a unit can be loaded.

Proper Usage

Pedestals and File Centers

Any pedestal or file center that is attached to the underside of a work surface must have glides adjusted to support the weight of the pedestal or file center.

Lateral Files

CAUTION: Any freestanding lateral file, if improperly used or loaded, can tip. Since files may contain significant weight, this tipping can result in serious damage and/or personal injury. For proper and safe performance, read and follow instructions provided with each file.

Do not attempt to open more than one lateral file drawer at a time. Do not use drawers as steps. Failure to follow these instructions may cause tipping of cabinet, resulting in personal injury.

Use counterbalance weights whenever lateral files or pedestals are not anchored or ganged back-to-back.

To avoid tipping, always load bottom drawers before loading top drawer.

Filing and Storage Offering

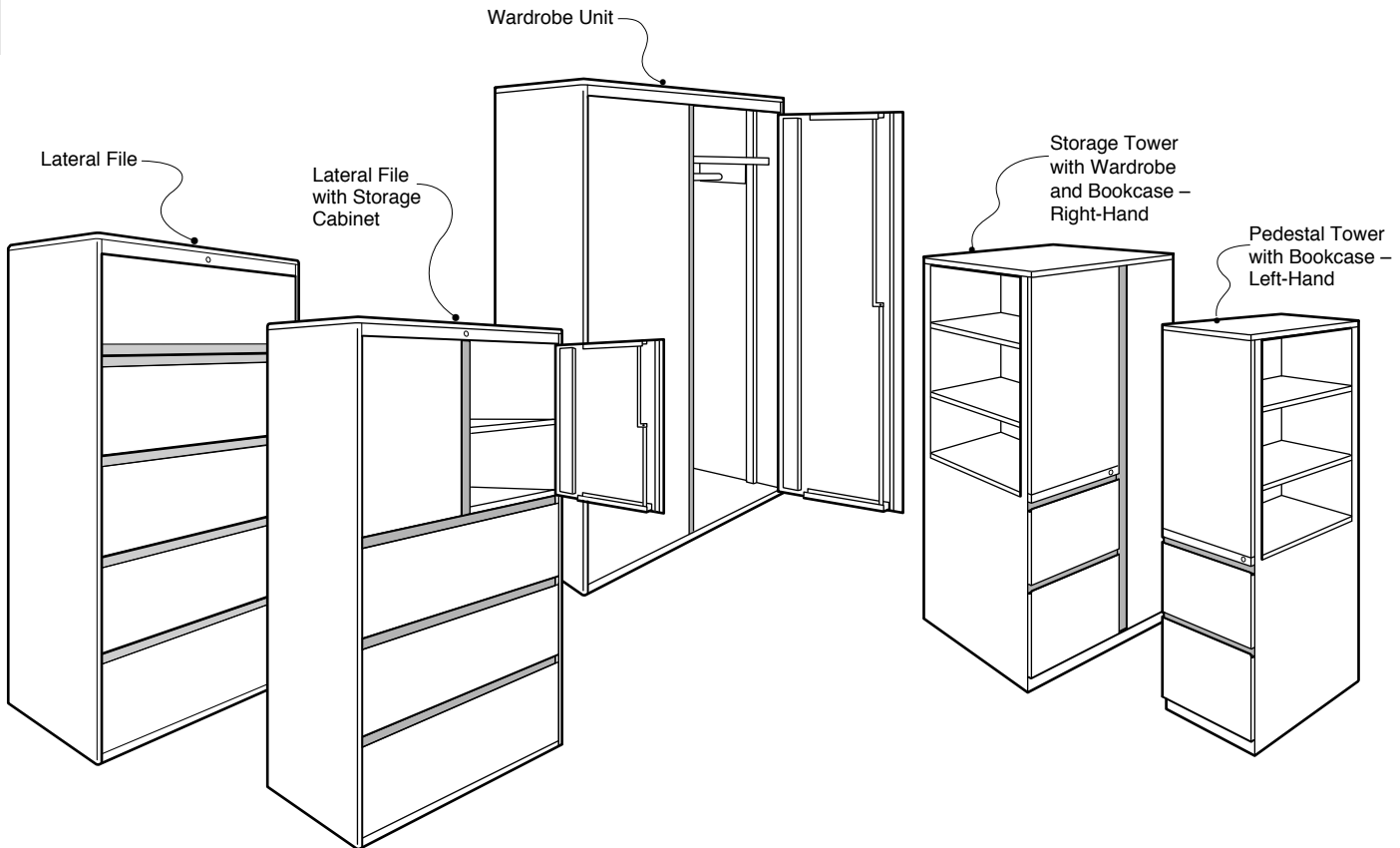

Glide Adjustment Ranges

Pedestals	
Choices	1 ⁵ / ₈ " (41)
Lateral Files	
Choices	5 ⁵ / ₈ " (16)
Bookcases	5 ⁵ / ₈ " (16)
Choices Storage Towers	
Storage Tower w/Wardrobe	5 ⁵ / ₈ " (16)
Storage Tower w/Wardrobe and Bookcase	1 ¹ / ₂ " (38)
Pedestal Tower w/Bookcase	1 ¹ / ₂ " (38)
Choices File Centers	
Floor Supported File Center	1 ⁵ / ₈ " (41)
Pedestal Lateral File Center	1 ³ / ₈ " (35)

Keyed Alike

Choices filing and storage units have two lock options to choose from. Units can be randomly keyed (option "R") or they can be key-alike (option "T") for no additional upcharge. When the randomly keyed option "R" is chosen the Choices

filing and storage unit will ship with a randomly numbered core/key.

When the key-alike lock option "T" is chosen the Choices filing unit will ship with a "disposable" core in place of the core/key and the specified Choices Core/Key set(s) will be packaged separately for field installation. The "disposable" core must be field replaced with a Choices Core/Key set in order for the Choices filing unit to lock. The Core/Key set (LCAK) must be ordered separately.

Ordering Information

For ease in specifying, Trendway's catalog numbering system uses meaningful characters to convey description, surface type, and size. For example, LFS530 represents a Choices **L**ateral **F**ile with **S**torage Cabinet, **5**-High by **30**" (762) -wide.

Trendway has further simplified the order process by having all the options available for a product listed in the price chart. By following the Sample Part Number Example at the bottom of each page, you create a Part Number for each product. This Part Number will match your acknowledgement and packing slip.

When ordering filing and storage units, list the following:

1. Quantity (combine same products)
2. Complete Part Number (see Sample Part Number at the bottom of each page for correct number sequence).
3. For ease of reading, place a period between each option number (FSLF536E.J.K).

Sample Part Number:	Catalog Number	Trim Color	Accent Strip Color
	FSLF536E	.J	.K
Total Cost \$2128 =	\$2128	+ N/C	+ N/C

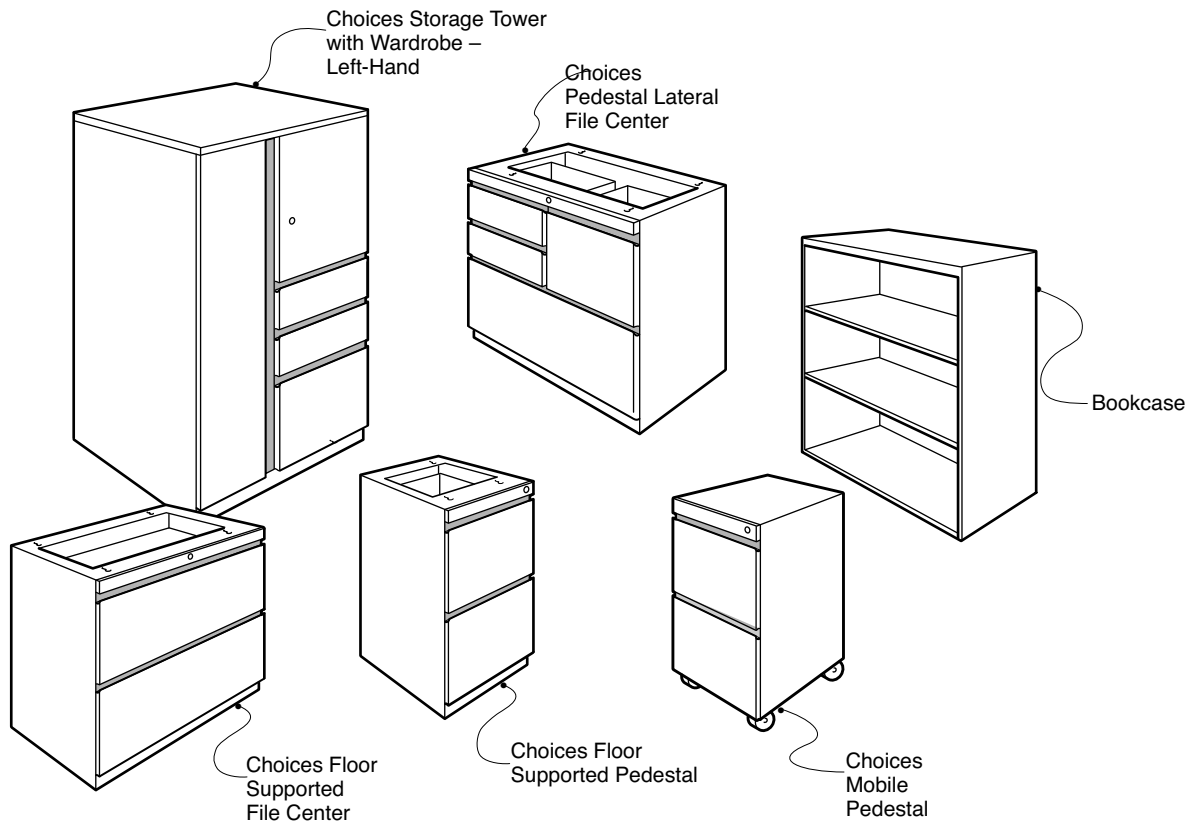

Lateral File Front-to-Back Conversion Bar Application Guide

The Choices Freestanding Traverse Kit (FSTK) is used to convert letter and legal size folders to front-to-back filing in Lateral File drawers. The diagram below illustrates capacity and how many Traverse Kits to order for each application.

Choices Freestanding Traverse Kit

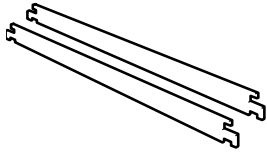

For use with Choices Lateral Files,
Choices Lateral File Centers, Choices
Lateral File with Storage Cabinets

Letter Size Filing

Legal Size Filing

30" - Wide

30" - Wide

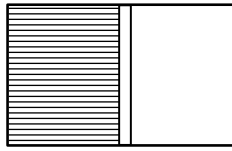
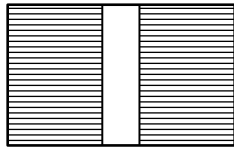

1 Choices Freestanding
Traverse Kit

1 Choices Freestanding
Traverse Kit

36" - Wide

36" - Wide

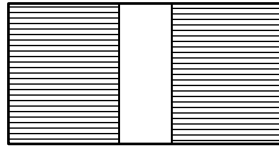
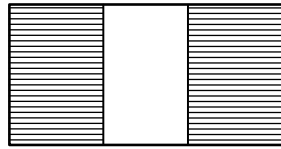

1 Choices Freestanding
Traverse Kit

1 Choices Freestanding
Traverse Kit

42" - Wide

42" - Wide

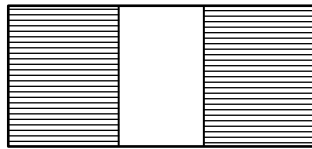
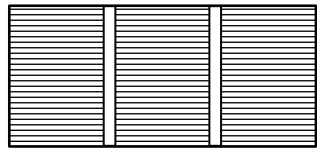

2 Choices Freestanding
Traverse Kits

1 Choices Freestanding
Traverse Kit

Lateral File Top Specification Guide

Lateral File Tops are available for use with one, two or four lateral file unit combinations. For non-standard sizes, contact Trendway Custom Solutions 1-800-893-8117.

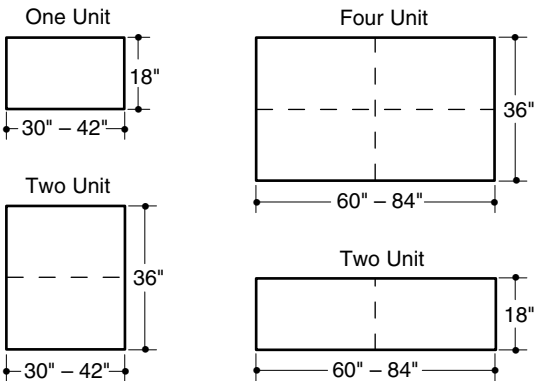

Choices Keying Order Form

This form can be used as a worksheet or an order form to determine what key alike Choices Core/Key Sets are needed for key-alike Choices filing and storage, Choices locks on Choices and Contrada flipper units and for additional Choices Lock Keys, Core Keys and Master Keys*. It is also used to specify special tagging instructions to designate installation locations, which is offered free of charge.

The information on this form can either be entered in Trendway's design software, or through Trendway On-line Order Entry on Trenddealer.com using the catalog numbers listed below or it can be used as an order form and faxed to Trendway Customer Care.

Choices Core/Key Set

The Choices Core/Key Set is needed when the Key Alike Option 'T' is selected, or if a lock needs to be changed out in an existing unit. The Core/Key Set provides the ability to pick the key number for a single storage piece, each individual office or group of offices. Choices Core/Key Sets includes a lock core and 2 lock keys. Additional lock keys are available.

Choices Core Installation/Removal Key

Pack Core Installation/Removal Key is needed to install Core/Key Sets and to remove or replace existing Pack lock cores.

*Choices Master Key

Choices Master Key is used to open any Choices style lock. Master keys are sent out separately from the product order. Request for Master keys must be made on the end users letterhead and faxed to Trendway Customer Care at 1-800-893-8212. Orders are shipped within 24-hours of receipt.



Choices Keying Order Form

Trendway Corporation
P.O. Box 9016 Holland MI 49422-9016
Phone: (800) 968-5344 Fax: (616) 399-0668
www.trendway.com

Customer P.O. Number _____ Trendway Order Number _____

Ship To address if different from P.O. _____

Choices Core/Key Set – LCAK (Choices Lock Cores are Black in color)

Qty.	List Price \$9	Key Number M101-M200	Key—Alike Special Tagging Instructions		
			Floor	Office	
2	\$18	0	3	5	John's Office
6	\$54	0	2		Offices 201, 252

Additional Choices Lock Key(s) – LKS

Qty.	List Price \$4	Key Number M101-M200	Key—Alike Special Tagging Instructions		
			Floor	Office	
1	\$4	M101			

Additional Choices Core Installation/Removal Key(s) - CRK

Qty.	List Price \$4
3	\$12

Choices Master Key(s)

Choices Master Keys are used to open any Choices style lock. Master keys are sent separately from the product order. Requests for Master keys must be made on the end-user's letterhead and faxed to Trendway Customer Care at 1-800-893-8212. Orders are shipped within 24 hours of receipt.

Choices Core/Key Set



The Choices Core/Key Set must be ordered when the Key-Alike Lock option is chosen to replace the "disposable" core that ships with Choices filing units in order for these units to lock. This set can also be ordered to replace an existing Choices Core/Key Set. The set includes a Choices lock core and 2 lock keys.

Choices Core Installation/Removal Key

Choices Core Installation/Removal Key is needed to install or remove Choices Cores in Choices filing units.

Choices Keys

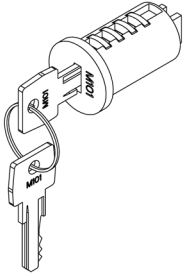
Replacement Choices Keys are available for order.

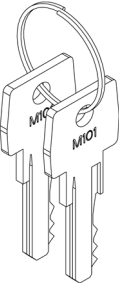
Choices Core/ Key Sets			
	List Price	Catalog Number	Key Number
	\$9	LCAK	M101-M200
Choices Core Installation/Removal Key			
	List Price	Catalog Number	
	\$4	CRK	
Choices Lock Keys			
	List Price	Catalog Number	Key Number
	\$4	LKS	M101-M200
Build your complete Part Number here:		_ _ _ _ _	_

Sample Part Number:

_ LKS _ _ _	M102
-------------	------

Total Cost \$4 =

\$4	+	N/C
-----	---	-----

Choices Storage Tower with Wardrobe

The Choices Storage Tower with Wardrobe provides coat, drawer, and cupboard storage in a single cabinet. The Tower is available in two heights and in either a Right-Hand version with the wardrobe on the right side, or a Left-Hand version with the wardrobe on the left side.

The Tower is constructed of painted metal and has adjustable leveling glides. The cupboard door and the drawers have one common lock. The cupboard unit includes one adjustable painted metal shelf. The pedestal includes painted

metal drawer fronts. 6" (152) and 12" (305) drawers have full extension ball-bearing slides. Doors and pedestal drawer fronts include Choices Accent Strips.

Available accessories include Choices Pedestal Divider/Conversion Kit (PCD), Choices Pencil Tray (HPPT), Lateral File Dividers (LFDE) and Shelf/File Dividers (SDIV).

Note: The Choices Storage Tower Wardrobe door does not lock.

When the key-alike lock option "T" is chosen a "disposable" core is assembled in the filing unit to temporarily secure the drawers and doors for transit. The "disposable" cores must be field replaced with Choices Core/Key Sets in order for the Choices filing unit to lock. Core/Key Sets (LCAK) must be ordered separately or by using the keying order form.

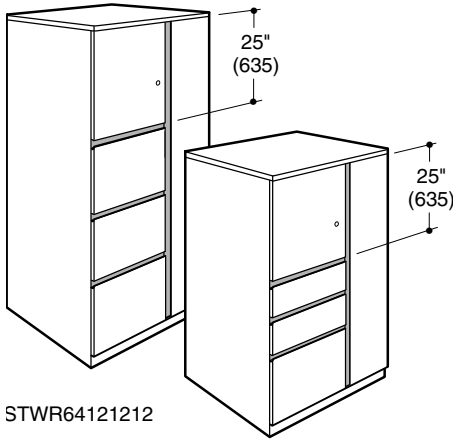

STWR64121212

STWR526612

Choices Storage Tower with Wardrobe – Right-Hand

Depth	Dimensions Width Height	List Price	Catalog Number	Trim Color	Accent Strip Color	Lock
23 1/2" (597)	23 1/2" (597) 52" (1321)	\$2355 2472	STWR521212 STWR526612	Standard Finishes No Cost	K Charcoal	R No Cost
	64 1/8" (1641)	\$2501 2620	STWR64121212 STWR64661212	Premium Finishes + \$108 See Surface Materials Page 3	Or Repeat Trim Color in Standard Smooth Finish For Color Matched.	*T Deduct - \$9 Key-Alike *Note: Be sure to order Core/Key Sets (LCAK) separately (1 per unit)

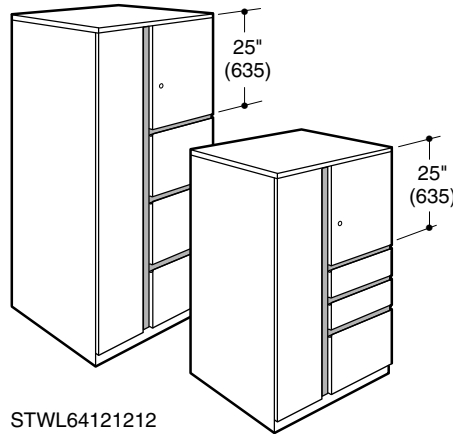

STWL64121212

STWL526612

Choices Storage Tower with Wardrobe – Left-Hand

Depth	Dimensions Width Height	List Price	Catalog Number
23 1/2" (597)	23 1/2" (597) 52" (1321)	\$2355 2472	STWL521212 STWL526612
	64 1/8" (1641)	\$2501 2620	STWL64121212 STWL64661212
Build your complete Part Number here:			
_ _ _ _ _			

Sample Part Number:

STWR526612	.J	.K	.R
_ _ _ _ _	_	_	_

Total Cost \$2472 =

\$2472	+	N/C	+	N/C	+	N/C
--------	---	-----	---	-----	---	-----

Choices Storage Tower with Wardrobe and Bookcase

The Choices Storage Tower with Wardrobe and Bookcase provides coat, drawer and bookcase storage in a single cabinet.

The Tower is available in two heights and in either a Right-Hand version with the wardrobe on the right side, or a Left-Hand version with the wardrobe on the left side.

The Tower is constructed of painted metal. Includes lockable drawers with painted metal drawer fronts and adjustable leveling glides. 6" (152) and 12" (305) drawers

have full extension ball-bearing slides. Doors and pedestal drawer fronts include Choices Accent Strips.

The 52" (1321) Tower has one adjustable painted metal shelf that allows for one row of binder storage plus additional storage in the bookcase. The 64 1/8" (1641) Tower has two adjustable painted metal shelves that allow for two rows of binder storage plus additional storage in the bookcase.

Available accessories include Choices Pedestal Divider/Conversion Kit (PCD), Choices Pencil Tray (HPPT), Lateral File

Dividers (LFDE) and Shelf/File Dividers (SFDIV).

Note: The Choices Storage Tower Wardrobe door does not lock.

When the key-alike lock option T" is chosen a "disposable" core is assembled in the filing unit to temporarily secure the drawers and doors for transit. The "disposable" cores must be field replaced with Choices Core/Key Sets in order for the Choices filing unit to lock. Core/Key Sets (LCAK) must be ordered separately or by using the keying order form.

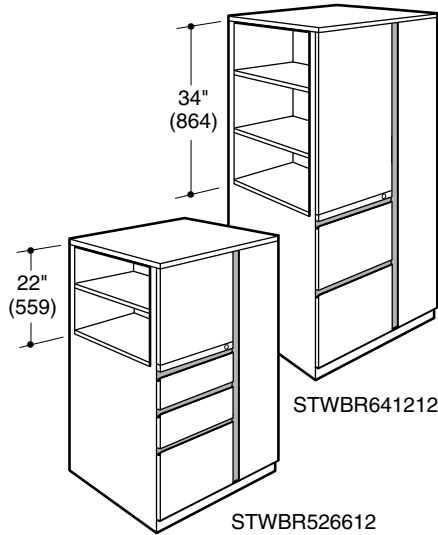

Choices Storage Tower with Wardrobe and Bookcase – Right-Hand

Dimensions		Number of Shelves	List Price	Catalog Number	Trim Color	Accent Strip Color	Lock
Depth	Width						
23 1/2" (597)	23 1/2" (597)	52" (1321) 1	\$2207	STWBR521212 STWBR526612	Standard Finishes No Cost	K Charcoal	R No Cost
		64 1/8" (1641) 2	\$2355 2472				

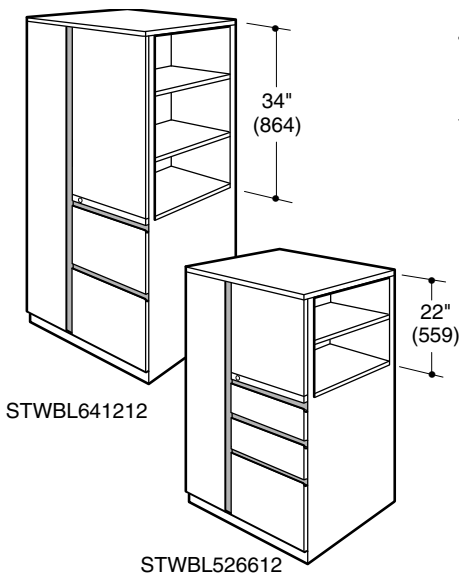

Choices Storage Tower with Wardrobe and Bookcase – Left-Hand

Dimensions		Number of Shelves	List Price	Catalog Number
Depth	Width			
23 1/2" (597)	23 1/2" (597)	52" (1321) 1	\$2207	STWBL521212 STWBL526612
		64 1/8" (1641) 2	\$2355 2472	

Build your complete Part Number here:

-----	-	-	-
-------	---	---	---

Sample Part Number:

STWBR526612	.J	.K	.R
-------------	----	----	----

Total Cost \$2325 =

\$2325	+	N/C	+	N/C	+	N/C
--------	---	-----	---	-----	---	-----

Choices Pedestal Tower with Bookcase

The Choices Pedestal Tower with Bookcase combines the functionality of a pedestal with the added storage of a bookcase.

The Tower is available in Right- and Left-Hand versions. The Right-Hand version is intended for placement on the right-hand of a work station with the bookcase facing inward. The Left-Hand version is intended for placement on the left-hand of a work station with the bookcase facing inward.

The Tower is constructed of painted metal and has adjustable leveling glides. The bookcase unit includes two adjustable shelves that accommodate two rows of binder storage plus additional storage. The pedestal includes lockable drawers with painted metal drawer fronts. 6" (152) and 12" (305) drawers have full extension ball-bearing slides. Pedestal drawer fronts include Choices Accent Strips.

Available accessories include Choices Pedestal Divider/Conversion Kit (PCD), Choices Pencil Tray (HPPT), Lateral File Dividers (LFDE) and Shelf/File Dividers (SFDIV).

When the key-alike lock option T" is chosen a "disposable" core is assembled in the filing unit to temporarily secure the drawers and doors for transit. The "disposable" cores must be field replaced with Choices Core/Key Sets in order for the Choices filing unit to lock. Core/Key Sets (LCAK) must be ordered separately or by using the keying order form.

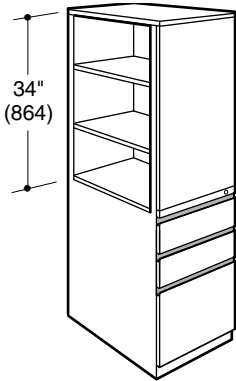

Choices Pedestal Tower with Bookcase – Right-Hand

Depth	Dimensions Width	Height	List Price	Catalog Number	Trim Color	Accent Strip Color	Lock
23 1/2" (597)	15 1/4" (387)	64 1/8" (1641)	\$1295 1309	PTBR641212 PTBR646612	Standard Finishes No Cost Premium Finishes + \$60 See Surface Materials Page 3	K Charcoal Or Repeat Trim Color in Standard Smooth Finish For Color Matched.	R No Cost Random *T Deduct - \$9 Key-Alike *Note: Be sure to order Core/Key Sets (LCAK) separately (1 per unit)

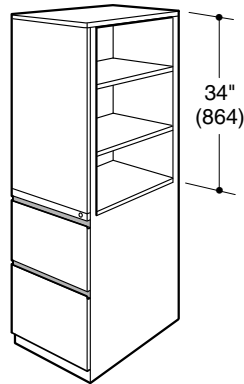

Choices Pedestal Tower with Bookcase – Left-Hand

Depth	Dimensions Width	Height	List Price	Catalog Number
23 1/2" (597)	15 1/4" (387)	64 1/8" (1641)	\$1295 1309	PTBL641212 PTBL646612

Build your complete Part Number here:

-----	-	-	-
-------	---	---	---

Sample Part Number:

PTBR646612	.J	.K	.R
------------	----	----	----

Total Cost \$1309 =

\$1309	+	N/C	+	N/C	+	N/C
--------	---	-----	---	-----	---	-----

CHOICES LATERAL FILES

Lateral Files are constructed of metal and include full-extension ball-bearing slides, leveling glides, and one plastic label holder per drawer. Drawer fronts are painted metal with accent strips.

Lateral Files include locks. Drawers accommodate side-to-side letter, A4, legal, EDP filing, and include a safety interlock mechanism that allows only one drawer to open at a time.

Accessories include the Choices Freestanding Traverse Kit (FSTK), Lateral File Dividers (LFDE), Choices Lateral File Tops (LFT) and Choices Lateral File Counterbalance Weights (CBWL).

Note: Lateral File Counterbalance Weights are required for individual lateral files that are not anchored or ganged back-to-back.

Choices Five-Drawer Lateral Files

The Five-Drawer model has four lateral drawers and a receding top door with roll-out shelf. Roll-out shelf includes 3 LFDE Lateral File Dividers.

When the key-alike lock option T" is chosen a "disposable" core is assembled in the filing unit to temporarily secure the drawers and doors for transit. The "disposable" cores must be field replaced with Choices Core/Key Sets in order for the Choices filing unit to lock. Core/Key Sets (LCAK) must be ordered separately or by using the keying order form.

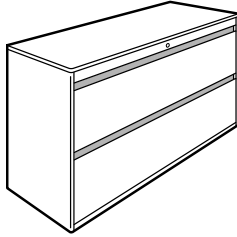

Choices Two-Drawer Lateral Files

Depth	Dimensions Width	Height	List Price	Catalog Number	Accent Trim Color	Strip Color	Lock
17 ³ / ₈ " (441)	30" (762)	27 ³ / ₄ " (705)	\$ 917	ⓔ FSLF230E	ⓔ Standard Finishes No Cost	ⓔ K Charcoal	ⓔ R No Cost Random
	36" (914)	27 ³ / ₄ " (705)	1033	ⓔ FSLF236E			
	42" (1067)	27 ³ / ₄ " (705)	1146	ⓔ FSLF242E			

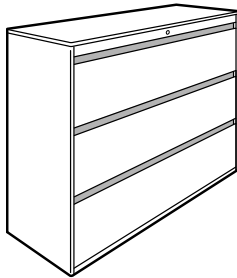

Choices Three-Drawer Lateral Files

Depth	Dimensions Width	Height	List Price	Catalog Number	Accent Trim Color	Strip Color	Lock
17 ³ / ₈ " (441)	30" (762)	39 ⁷ / ₈ " (1013)	\$1202	FSLF330E	ⓔ Premium Finishes + \$60 2-Drawer	Or Repeat Trim Color in Standard Smooth Finish For Color Matched.	ⓔ *T Deduct - \$9 Key-Alike
	36" (914)	39 ⁷ / ₈ " (1013)	1340	ⓔ FSLF336E			
	42" (1067)	39 ⁷ / ₈ " (1013)	1494	ⓔ FSLF342E			

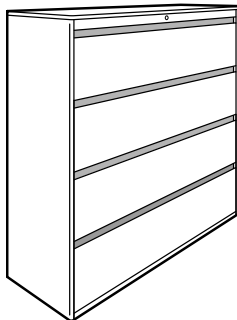

Choices Four-Drawer Lateral Files

Depth	Dimensions Width	Height	List Price	Catalog Number	Accent Trim Color	Strip Color	Lock
17 ³ / ₈ " (441)	30" (762)	52" (1321)	\$1514	FSLF430E	+ \$108 3, 4 and 5-Drawer	See Surface Materials Page 3	*Note: Be sure to order Core/Key Sets (LCAK) separately (1 per unit)
	36" (914)	52" (1321)	1679	FSLF436E			
	42" (1067)	52" (1321)	1866	FSLF442E			

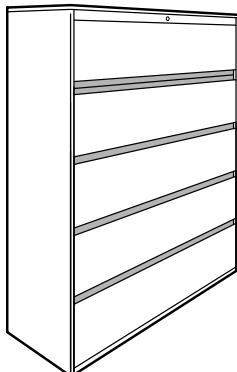

Choices Five-Drawer Lateral Files

Depth	Dimensions Width	Height	List Price	Catalog Number	Accent Trim Color	Strip Color	Lock
17 ³ / ₈ " (441)	30" (762)	64 ¹ / ₈ " (1629)	\$1922	FSLF530E			
	36" (914)	64 ¹ / ₈ " (1629)	2128	ⓔ FSLF536E			
	42" (1067)	64 ¹ / ₈ " (1629)	2345	ⓔ FSLF542E			

Build your complete Part Number here: _____

Sample Part Number:

FSLF536E	.J	.K	.R
----------	----	----	----

Total Cost \$2128 =

\$2128	+	N/C	+	N/C	+	N/C
--------	---	-----	---	-----	---	-----

ⓔ notes the item is available on Express

Choices Lateral File with Storage Cabinet

The Choices Lateral File with Storage Cabinet features three lateral file drawers below an integrated hinged double-door storage cabinet with one fixed and one adjustable shelf. Cabinet, drawer and door construction is painted metal. Includes full-extension ball-bearing slides, leveling glides, and one plastic label holder per drawer. There are two separate keyed alike locks for drawers and double-doors. Drawers include a safely interlock mechanism. Drawers and doors have Choices Accent Strips.

Note: Choices Lateral File with Storage Cabinets use Choices Lateral File accessories.

Note: Lateral File Counterbalance Weights are required for individual lateral files that are not anchored or ganged back-to-back.

When the key-alike lock option T" is chosen a "disposable" core is assembled in the filing unit to temporarily secure the drawers and doors for transit. The "disposable" cores must be field replaced with Choices Core/Key Sets in order for the Choices filing unit to lock. Core/Key Sets (LCAK) must be ordered separately or by using the keying order form.

Note: For Lateral File with Storage Cabinet; If "R" is chosen the same random lock number will be assembled in each of the 2 lock locations.

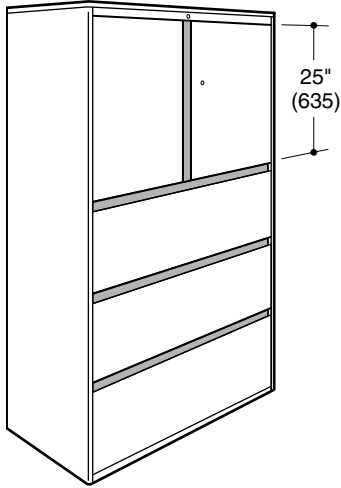

Choices Lateral File with Storage Cabinet

Depth	Dimensions Width Height	List Price	Catalog Number	Trim Color	Accent Strip Color	Lock
17 ³ / ₈ " (441)	30" (762)	\$2096	LFS530 LFS536 LFS542	Standard Finishes No Cost Premium Finishes + \$108 See Surface Materials Page 3	K Charcoal Or Repeat Trim Color in Standard Smooth Finish For Color Matched.	R No Cost Random
	36" (914)	2310				*T Deduct - \$18 Key-Alike
	42" (1067)	2576				*Note: Be sure to order Core/Key Sets (LCAK) separately (2 per unit)
Build your complete Part Number here:			---	-	-	-

Sample Part Number:

LFS542	.J	.K	.R
--------	----	----	----

Total Cost \$2576 =

\$2576	+	N/C	+	N/C	+	N/C
--------	---	-----	---	-----	---	-----

Choices Double-Door Storage Units

Choices Double-Door Storage Units are available in heights to match the two, three and five-high Choices Lateral Files. The units are constructed of painted metal and have locking doors with Choices Accent Strips. Painted metal shelves adjust vertically in 2" (51) increments.

Additional Storage Shelves (SS) are available.

Note: Choices Lateral File Tops (LFT) can be used on Choices Double-Door Storage Units.

Choices Wardrobe Units

The Choices Wardrobe Unit is constructed of painted metal and has locking doors with Choices Accent Strips. Includes one painted metal shelf with attached, full-width wardrobe bar.

When the key-alike lock option T" is chosen a "disposable" core is assembled in the filing unit to temporarily secure the drawers and doors for transit. The "disposable" cores must be field replaced with Choices Core/Key Sets in order for the Choices filing unit to lock. Core/Key Sets (LCAK) must be ordered separately or by using the keying order form.

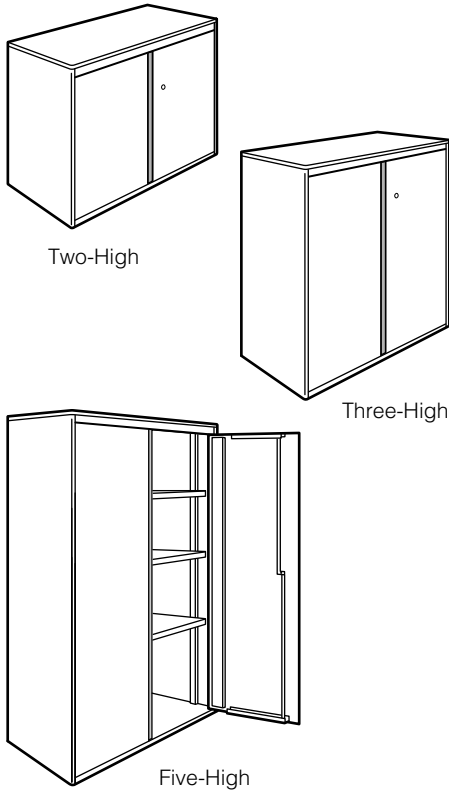

Choices Double-Door Storage Units

Depth	Dimensions Width	Height	Number of Shelves	List Price	Catalog Number	Trim Color	Accent Strip Color	Lock
17 ³ / ₈ " (441)	36" (914)	27 ³ / ₄ " (705)	1-Shelf	\$ 966	DD236E	Standard Finishes No Cost Premium Finishes + \$60 2-High + \$108 3 and 5-High See Surface Materials Page 3	K Charcoal Or Repeat Trim Color in Standard Smooth Finish For Color Matched.	R No Cost Random *T Deduct - \$9 Key-Alike *Note: Be sure to order Core/Key Sets (LCAK) separately (1 per unit)
		39 ⁷ / ₈ " (1013)	2-Shelves	1096	DD336E			
		64 ¹ / ₈ " (1629)	3-Shelves	1525	DD536E			

Choices Wardrobe Units

Depth	Dimensions Width	Height	List Price	Catalog Number
17 ³ / ₈ " (441)	36" (914)	64 ¹ / ₈ " (1629)	\$1244	WR536E

Build your complete
Part Number here:

---	-	-	-
-----	---	---	---

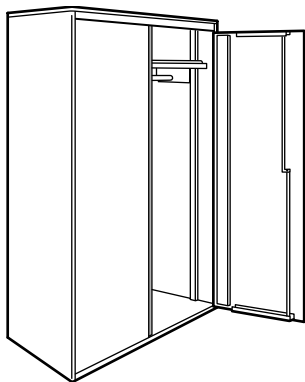

Sample
Part Number:

WR536E	.J	.K	.R
--------	----	----	----

Total Cost \$1244 =

\$1244	+	N/C	+	N/C	+	N/C
--------	---	-----	---	-----	---	-----

DOUBLE-DOOR, AND WARDROBE ACCESSORIES

Storage Shelves

The Storage Shelf fits in Choices Double-Door Storage Units and in Choices Lateral File with Storage Cabinets for additional shelf space. Includes 4 shelf clips.

Note: Storage Shelves accommodate Choices Double-Door Storage Units purchased after June 1, 2003.

Wardrobe Bars

The Wardrobe Bar converts a five-high Double-Door Storage Unit to a Wardrobe Unit. Wardrobe Bar attaches to the Storage Shelf.



Storage Shelves

Depth	Dimensions Width	Height	List Price	Catalog Number	Trim Color
15 ³ / ₈ " (391)	30" (762)	1" (25)	\$56	SS30E2	Standard Finishes No Cost Premium Finishes + \$19 See Surface Materials Page 3
	36" (914)	1" (25)	56	SS36E2	
	42" (1067)	1" (25)	56	SS42E2	

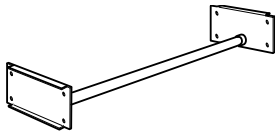

Wardrobe Bars (For Five-High Double-Door Storage Unit)

Dimensions Width	Height	List Price	Catalog Number
36" (914)	1" (25) Diameter	\$68	WRB36E

Build your complete
Part Number here:

_____	_____
-------	-------

Sample
Part Number:

WRB36E	.G
--------	----

Total Cost \$68 =

\$68	+	N/C
------	---	-----

Choices Floor-Supported File Centers

The Choices Floor-Supported File Center is intended for use under work surfaces. It aesthetically integrates with Floor-Supported Pedestals with matching drawer fronts and base details. The File Center has full extension ball bearing slides. Available accessories include the Choices Freestanding Traverse Kit (FSTK) for front-to-back filing, Lateral File Dividers (LFDE) and Choices Label Holders (LH).

Choices Pedestal Lateral File Center

The Choices Pedestal Lateral File Center combines the functionality of a pedestal and the lateral file into a single cabinet that fits below a systems work surface or a desk module. It is designed to visually integrate with Choices Floor-Supported Pedestals.

Units are constructed of metal and include full-extension ball bearing slides on all drawers. Drawer fronts are painted metal with Choices pull Accent Strips. Available accessories include the Choices Freestanding Traverse Kit (FSTK) for front-to-back filing, Lateral File Dividers (LFDE),

Choices Label Holders (LH), Choices Pedestal Divider/Conversion Kit (PCD) and Choices Pencil Tray (HPPT).

Note: File center must be attached to a panel-mounted work surface or a desk unit.

When the key-alike lock option T" is chosen a "disposable" core is assembled in the filing unit to temporarily secure the drawers and doors for transit. The "disposable" cores must be field replaced with Choices Core/Key Sets in order for the Choices filing unit to lock. Core/Key Sets (LCAK) must be ordered separately or by using the keying order form.

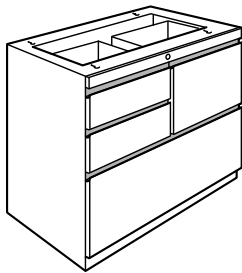
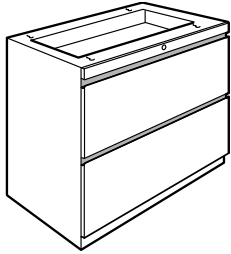

Choices Floor-Supported File Centers

Depth	Dimensions Width	Height	List Price	Catalog Number	Trim Color	Accent Strip Color	Lock
18 ³ / ₁₆ " (462)	30 ¹ / ₂ " (775)	27 ³ / ₄ " (705)	\$756	FSFC30E	Standard Finishes No Cost	K Charcoal	R No Cost Random
18 ³ / ₁₆ " (462)	36 ¹ / ₂ " (917)	27 ³ / ₄ " (705)	853	FSFC36E			

Choices Pedestal Lateral File Center

Depth	Dimensions Width	Height	List Price	Catalog Number
18 ³ / ₁₆ " (460)	30 ¹ / ₂ " (775)	27 ³ / ₄ " (705)	\$1150	PLF306612

Build your complete Part Number here:

---	---	---	---
-----	-----	-----	-----

Sample Part Number:

FSFC36E	.G	.G	.R
---------	----	----	----

Total Cost \$853 =

\$853	+	N/C	+	N/C	+	N/C
-------	---	-----	---	-----	---	-----

Choices Lateral File Tops

Choices Lateral File Tops are sized to be used with Choices Two-Drawer, Three-Drawer, Four-Drawer and Five-Drawer Lateral Files. They are available for use with a single lateral file or combination of two or four lateral files. Lateral File Tops have a high-pressure laminate surface with vinyl edge. Tops are nominal 1 1/4" (32) thick.

Note: 18" (457)-deep Lateral File Tops are sized to fit between Return Panels and can also be used in freestanding applications. 36" (914)-deep Lateral File Tops are sized for freestanding applications only.

For non-standard sizes, contact Trendway Custom Solutions 1-800-893-8117.

See Lateral File Top Specification Guide in the Planning section.

Note: Lateral File Tops cannot be used in place of counterbalance weights, ganging or anchoring.

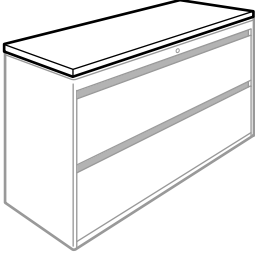

Choices Lateral File Tops

Nominal Depth	Dimensions		Actual Width	List Price	Catalog Number	Laminate Color	Edge Color
	Nominal Width	Actual Depth					
18" (457)	30" (762)	17 ⁵ / ₈ " (448)	29 ¹⁵ / ₁₆ " (760)	\$181	LFT1830E	See Surface Materials Page 3	See Surface Materials Page 3
	36" (914)		35 ¹⁵ / ₁₆ " (913)	197	LFT1836E		
	42" (1067)		41 ¹⁵ / ₁₆ " (1065)	218	LFT1842E		
	60" (1524)		59 ¹⁵ / ₁₆ " (1522)	277	LFT1860E		
	66" (1676)		65 ¹⁵ / ₁₆ " (1675)	301	LFT1866E		
	72" (1829)		71 ¹⁵ / ₁₆ " (1827)	320	LFT1872E		
	78" (1981)		77 ¹⁵ / ₁₆ " (1980)	323	LFT1878E		
	84" (2134)		83 ¹⁵ / ₁₆ " (2132)	324	LFT1884E		
36" (914)	30" (762)	35" (889)	30 ³ / ₁₆ " (767)	\$262	LFT3630E		
	36" (914)		36 ³ / ₁₆ " (919)	296	LFT3636E		
	42" (1067)		42 ³ / ₁₆ " (1072)	332	LFT3642E		
	60" (1524)		60 ³ / ₁₆ " (1529)	377	LFT3660E		
	66" (1676)		66 ³ / ₁₆ " (1681)	424	LFT3666E		
	72" (1829)		72 ³ / ₁₆ " (1834)	435	LFT3672E		
	78" (1981)		78 ³ / ₁₆ " (1986)	438	LFT3678E		
	84" (2134)		84 ³ / ₁₆ " (2138)	443	LFT3684E		
Build your complete Part Number here:					_____	—	—

Sample Part Number:

_____ LFT1842E	_____ .J	_____ .K
-------------------	-------------	-------------

Total Cost \$218 =

\$218	+	N/C	+	N/C
-------	---	-----	---	-----

CHOICES LATERAL FILE ACCESSORIES

Choices Lateral File Counterbalance Weights

The Choices Lateral File Counterbalance Weight **provides additional stability and must be used for individual lateral files that are not anchored or ganged back-to-back.** All hardware is included for field installation.

Choices Freestanding Traverse Kit

The Choices Freestanding Traverse Kit converts Choices Freestanding Lateral Files and Floor-Supported File Centers

from standard side-to-side filing to front-to-back filing.

Note: For each drawer, order one kit for 30" (762)- and 36" (914)-wide lateral files; order two kits for 42" (1067)-wide lateral files. See Lateral File Front-to-Back Conversion Bar Application Guide in the Planning section for further information.

Available in Black only.

Lateral File Dividers

The Lateral File Dividers are freestanding dividers that securely attach magnetically to a shelf or drawer bottom.

Available in Black only.

Choices Label Holders

The Choices Label Holder attaches to freestanding lateral file and pedestal drawers with pull accent strips. Packaged in boxes of 6. Includes label inserts.

Note: The required number of holders are included with each lateral file order; order extra Label Holders only when additional holders are needed.

Available in Clear Plastic only.

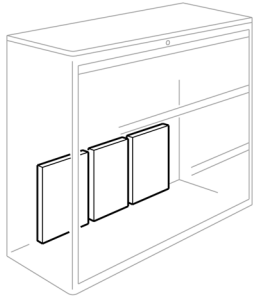

Choices Lateral File Counterbalance Weights

Description	Pieces	List Price	Catalog Number
For Two-Drawer Lateral File	4	\$161	Ⓢ CBWL2E
For Three-Drawer Lateral File	3	138	Ⓢ CBWL3E
For Four- and Five-Drawer Lateral File	2	70	Ⓢ CBWL4E

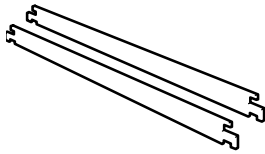

Choices Freestanding Traverse Kit

Description	List Price	Catalog Number
Includes 2 bars.	\$17	Ⓢ FSTK

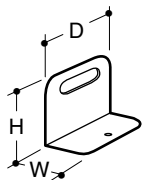

Lateral File Dividers

Depth	Dimensions Width	Height	List Price	Catalog Number
8" (203)	4" (102)	7 1/2" (191)	\$77	Ⓢ LFDE
Includes 3 dividers.				



Choices Label Holders

Description	List Price	Catalog Number
Includes 6 label holders.	\$27	LH
Build your complete Part Number here:		-----

Sample Part Number:

LFDE -----

Total Cost \$77 =

\$77

Ⓢ notes the item is available on Express

Choices Floor-Supported Pedestals

The Floor-Supported Pedestal mounts beneath the work surface. Includes lockable drawers, ball-bearing slides, 1³/₈" (41) leveling glides and mounting hardware. The 6" (152) drawers have 3/4 extension slides; the 12" (305) drawers fully extend. Pedestals are painted metal. Drawers have pull accent strips across the length of the pull.

Note: One pencil tray is included with the FSP6612E and FSPD6612E. Order drawer dividers and other drawer accessories separately.

Choices Mobile Pedestals

The Mobile Pedestal includes two locking and two non-locking casters, lockable drawers, ball-bearing slides, and a factory-installed counterbalance weight. The 6" (152) drawers have 3/4 extension slides; 12" (305) drawer slides fully extend. Pedestals are painted metal. Drawers have pull accent strips across the length of the pull.

Note: One pencil tray is included with the MP6612E. Order drawer dividers and other drawer accessories separately.

When the key-alike lock option T" is chosen a "disposable" core is assembled in the filing unit to temporarily secure the drawers and doors for transit. The "disposable" cores must be field replaced with Choices Core/Key Sets in order for the Choices filing unit to lock. Core/Key Sets (LCAK) must be ordered separately or by using the keying order form.

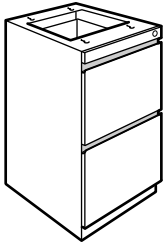

FSP1212E

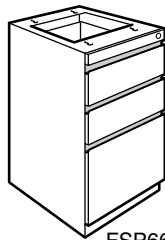

FSP6612E

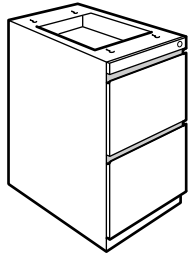

FSPD1212E

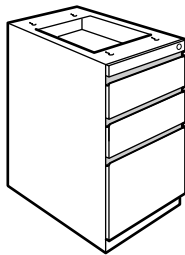

FSPD6612E

Choices Floor-Supported Pedestals

Depth	Dimensions Width	Height	List Price	Catalog Number	Trim Color	Accent Strip Color	Lock
22" (559)	15 ³ / ₁₆ " (386)	27 ³ / ₄ " (705)	\$588 617	ⓔ FSP1212E ⓔ FSP6612E	ⓔ Standard Finishes No Cost ⓔ Premium Finishes + \$48 See Surface Materials Page 3	ⓔ K Charcoal Or Repeat Trim Color in Standard Smooth Finish For Color Matched.	ⓔ R No Cost Random ⓔ *T Deduct - \$9 Key-Alike *Note: Be sure to order Core/Key Sets (LCAK) separately (1 per unit)
28" (711)	15 ³ / ₁₆ " (386)	27 ³ / ₄ " (705)	\$647 670	FSPD1212E FSPD6612E			

Choices Mobile Pedestals

Depth	Dimensions Width	Height	List Price	Catalog Number
22" (559)	15 ³ / ₁₆ " (386)	27 ³ / ₄ " (705)	\$734 838	MP1212E MP6612E
Build your complete Part Number here:				-----

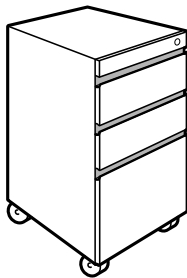
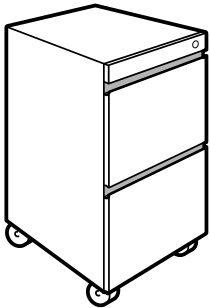

Sample Part Number:

FSP6612E	.J	.K	.R
-----	__	__	__

Total Cost \$617 =

\$617	+	N/C	+	N/C	+	N/C
-------	---	-----	---	-----	---	-----

ⓔ notes the item is available on Express

Choices 3/4 Mobile Pedestals

The Mobile Pedestal includes two locking and two non-locking casters, lockable drawers, ball-bearing slides, and a factory-installed counterbalance weight. Pedestals are painted metal. Drawers have pull accent strips across the length of the pull.

Note: One pencil tray is included with the MP612E. Order drawer dividers and other drawer accessories separately.

Choices Mobile Pedestal Cushion Top Kit

The Pedestal Cushion Top Kit includes upholstered cushion and four attached Velcro tabs to affix cushion. This cushion top can only be used on Choices Mobile Pedestals.

When the key-alike lock option "T" is chosen a "disposable" core is assembled in the filing unit to temporarily secure the drawers and doors for transit. The "disposable" cores must be field replaced with Choices Core/Key Sets in order for the Choices filing unit to lock. Core/Key Sets (LCAK) must be ordered separately or by using the keying order form.

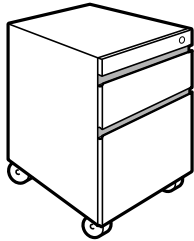

Choices 3/4 Mobile Pedestals

Depth	Dimensions Width	Height	List Price	Catalog Number	Trim Color	Accent Strip Color	Lock
22" (559)	15 ³ / ₁₆ " (386)	21" (533)	\$793	MP612E	Standard Finishes No Cost Premium Finishes + \$48 See Surface Materials Page 3	K Charcoal Or Repeat Trim Color in Standard Smooth Finish For Color Matched.	R No Cost Random *T Deduct - \$9 Key-Alike *Note: Be sure to order Core/Key Sets (LCAK) separately (1 per unit)

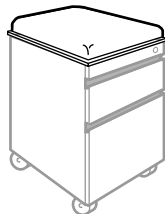

Choices Mobile Pedestal Cushion Top Kit

List Price Fabric Grade							Catalog Number	Seating Fabric Color
A	B	C	D	E	F	G		
\$162	\$178	\$191	\$209	\$230	\$251	\$277	MPCTK	See Surface Materials Page 4
Build your complete Part Number here:							_____	_____

Sample
Part Number:

MP612E	.J	.K	.R
_____	__	__	__

Total Cost \$793 =

\$793	+	N/C	+	N/C	+	N/C
-------	---	-----	---	-----	---	-----

PEDESTAL AND FILE CENTER ACCESSORIES

Choices Pedestal Divider/Conversion Kit (Also for use with File Centers)

The Pedestal Divider/Conversion Kit is used to divide drawer space in the 6" (152) drawer. The 12" (305) Divider/Conversion Kit is used to divide and compress letter size files, or can convert the 12" (305) drawer to side-to-side or legal-size filing.

Available in Black only.

Choices Pencil Tray

The Pencil Tray organizes small items in both the 6" (152) and 12" (305) Choices Pedestal drawers and Lateral File Center drawers.

Available in Black only.

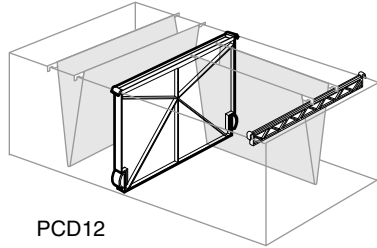

Choices Pedestal Divider/Conversion Kit

Width	Dimensions Height	Description	List Price	Catalog Number
12 ³ / ₄ " (324)	4 ⁵ / ₈ " (117) 9 ⁵ / ₈ " (244)	Includes 5 dividers. Includes 5 dividers and conversion bars.	\$38 63	Ⓢ PCD6 Ⓢ PCD12

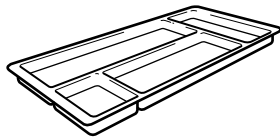

Choices Pencil Tray

Depth	Dimensions Width	Height	Description	List Price	Catalog Number
5 ¹ / ₂ " (140)	13 ³ / ₈ " (340)	1" (25)	Includes 1 pencil tray.	\$13	Ⓢ HPPT

Build your complete
Part Number here:

Sample
Part Number:

HPPT

Total Cost \$13 =

\$13

Ⓢ notes the item is available on Express

Pencil Drawer

The Pencil Drawer mounts beneath any work surface except certain Corner Work Surfaces*. The plastic drawer includes a built-in pencil tray and dividers, nylon slides and attachment hardware. Drawer is non-locking and offered in black only.

*Note: The Pencil Drawer will fit on Choices Panel Hung Corner Work Surfaces and Freestanding Corner Desks with front widths greater than 22" (559).

Center Drawer

The Center Drawer mounts beneath any work surface except certain Corner Work Surfaces*. The drawer includes a built-in pencil tray and dividers, full-extension ball-bearing slides, and attachment hardware. Drawer is non-locking, painted metal and available in all trim colors.

*Note: The Center Drawer will fit on Choices Panel Hung Corner Work Surfaces and Freestanding Corner Desks with front widths greater than 22" (559).

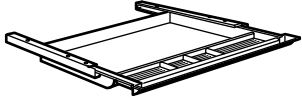

Pencil Drawer

Depth	Dimensions Width	Height	List Price	Catalog Number	
16 1/8" (410)	21 1/2" (546)	2" (51)	\$42	Ⓢ PDR	

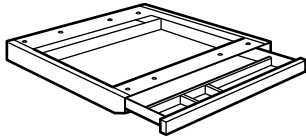

Center Drawer

Depth	Dimensions Width	Height	List Price	Catalog Number	Trim Color
18" (457)	20 1/2" (521)	1 5/8" (41)	\$200	Ⓢ CDW	Ⓢ Standard Smooth Finish Only See Surface Materials Page 3

Build your complete Part Number here:

_____	_____
-------	-------

Sample Part Number:

__ CDW __	__ .J __
-----------	----------

Total Cost \$200 =

\$200	+	N/C
-------	---	-----

Ⓢ notes the item is available on Express

Choices Bookcases

The Bookcase is complete with metal top and base with leveling glides. The Two-high case has one adjustable shelf; the three-high case has two adjustable shelves; the four-high case has three adjustable shelves; the five-high case has four adjustable shelves. The shelves are 1" (25)-thick, and adjust in 1/2" (13)-height increments. All Bookcase heights are designed to accommodate standard binders on all shelves.

Additional Bookcase Shelves (BCAS, BCBS, BCCS) are available.

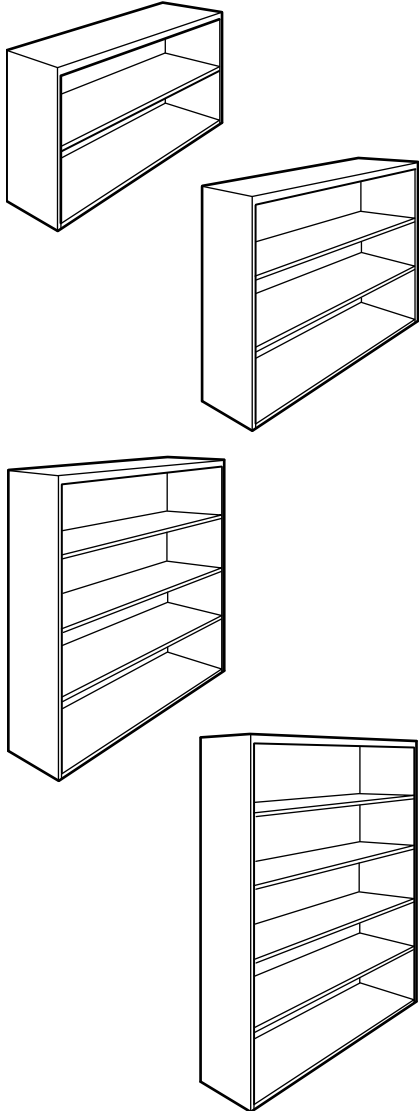

Choices Bookcases

Depth	Dimensions Width	Height	Units High	List Price	Catalog Number	Trim Color
13 ³ / ₈ " (340)	30" (762)	28" (711)	2-High	\$590	BCA230 BCA330 BCA430 BCA530	Standard Finishes No Cost
		41" (1041)	3-High	691		
		53 ³ / ₈ " (1356)	4-High	813		
		66 ³ / ₈ " (1686)	5-High	935		
13 ³ / ₈ " (340)	36" (914)	28" (711)	2-High	\$608	BCB236 BCB336 BCB436 BCB536	Premium Finishes + \$60 2-High + \$108 3, 4 and 5-High See Surface Materials Page 3
		41" (1041)	3-High	709		
		53 ³ / ₈ " (1356)	4-High	831		
		66 ³ / ₈ " (1686)	5-High	960		
13 ³ / ₈ " (340)	42" (1067)	28" (711)	2-High	\$ 678	BCC242 BCC342 BCC442 BCC542	
		41" (1041)	3-High	780		
		53 ³ / ₈ " (1356)	4-High	914		
		66 ³ / ₈ " (1686)	5-High	1051		
Build your complete Part Number here:						_ _ _ _ _ _

Sample
Part Number:

BCB536

.Y

Total Cost \$960 =

\$960

+

N/C

Choices Bookcase Shelves

Bookcase Shelves are used for additional shelf space. Includes one shelf and mounting hardware. Bookcase Shelves accommodate bookcases purchased after December 9, 2002.

Shelf/File Dividers

Shelf/File Dividers are freestanding dividers that securely attach magnetically to a shelf or drawer bottom. Includes three dividers. Available in all trim colors.



Choices Bookcase Shelves (For BCA, BCB and BCC Bookcases)

Fits Bookcase Width	Depth	Dimensions		List Price	Catalog Number	Trim Color
		Actual Width	Height			
30" (762)	12 ⁷ / ₈ " (327)	27 ⁵ / ₈ " (702)	1" (25)	\$70	BCAS30	Standard Finishes No Cost Premium Finishes + \$19 See Surface Materials Page 3
36" (914)		33 ⁵ / ₈ " (854)	1" (25)	70	BCBS36	
42" (1067)		39 ⁵ / ₈ " (1006)	1" (25)	70	BCCS42	

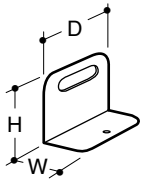

Shelf/File Dividers

Depth	Dimensions Width	Height	List Price	Catalog Number	Trim Color
8" (203)	4" (102)	7 ¹ / ₂ " (191)	\$81	SFDIV	Standard Smooth Finish Only See Surface Materials Page 3
Includes 3 dividers.					
Build your complete Part Number here:				-----	-

Sample Part Number:

BCBS36	.Y
--------	----

Total Cost \$70 =

\$70	+	N/C
------	---	-----

Terms & Policies

<u><i>Terms & Policies</i></u>	<u>32</u>
------------------------------------	-----------

1. Prices

Prices shown in this price list are F.O.B. origin, freight prepaid, in the contiguous United States. Trendway Corporation reserves the right to change prices without notice. Trendway may implement price changes effective at time of shipment if shipping date is more than 120 days from date written order was received by Trendway.

Pricing for shipments outside the contiguous United States will be based on the port of departure. Freight will be prepaid to port of departure.

List prices include coverage of prepaid standard, Trendway-specified freight cost. However your invoice will add a fuel contribution cost charge of 0.33% of list applied to all orders.

2. Order Placement

Trendway Corporation requires all orders to be submitted electronically via on-line order entry at www.trenddealer.com, or in writing following Ordering Procedures on page 1. Trendway recommends using design software for larger projects which allows the dealer to design, specify, and enter an order more efficiently and accurately which will assure completeness and avoid errors and duplications. The Buyer assumes all responsibility for the correct content of any order which has been acknowledged.

3. Confirmation

Upon receiving an order, Trendway Corporation will send an acknowledgement with exact pricing information and scheduled shipping date. Orders can also be confirmed on-line at www.trenddealer.com. Customer is responsible for checking acknowledgements to ensure that the order is correct. Order will be processed as acknowledged.

4. Lead Times

Trendway Corporation reserves the right to alter lead times as demand for products fluctuate. Stated lead times begin after an order is entered and scheduled. Ship-ments are subject to product availability. Special products and larger orders may extend lead times. Please contact your customer care representative for exact lead times.

5. Buyer's Credit

If, in the judgment of Trendway, the financial condition of the Buyer at any time does not justify the terms specified, Trendway may at any time by notice to the Buyer require prepayment or other terms of payment differing from those specified in Section 8 or other satisfactory security to insure prompt payment of invoices.

6. Order Changes

To change an order, the customer must call Trendway Customer Care for order status. If approved, the customer must confirm the changes in writing to Trendway Corporation. Customer agrees to accept any and all charges involved in altering an order. This includes payment, determined by Trendway, for product already in production. Changes in orders also may result in delayed shipments.

7. Cancellation

All cancellations must be approved by Trendway Corporation. **Orders in production cannot be cancelled without incurring substantial or full purchase price.** Customers shall agree to accept any and all charges involved in the cancellation transaction, as determined by Trendway. Non-standard items may not be cancelled.

8. Terms of Sale

Terms of sale on all invoices to approved Trendway customers are Net 30 days from date of invoice. These terms may be changed at any time by Trendway Corporation based on credit rating information available on specific customers. Payment in advance may be requested at the discretion of Trendway without explanation.

9. Taxes

Prices listed do not include any federal, state, local, or other taxes. Purchaser agrees to pay or reimburse any such taxes that Trendway Corporation, Trendway Corporation subcontractors, or suppliers are required to pay. For shipments to AZ, CA, CO, DC, FL, GA, IL, IN, KS, MA, MI, MN, MS, NJ, NY, OH, PA, TX and Canada, add appropriate tax rate. All authorized dealers should ensure that a resale exemption certificate is on file with Trendway Corporation.

10. Past-Due Accounts

Past-due accounts will be charged 1.5% per month. This is an annual rate of 18% or the highest legal rate on the unpaid balance. The purchaser agrees to pay all collection agency fees, court costs, and/or reasonable attorney fees incurred by Trendway in the collection of past-due balances.

11. Customer's Own Material (COM)

The Trendway COM program allows customers to use special materials. By complying with the COM testing for manufacturability procedure in the steps below, Trendway will be able to identify if your material is appropriate for application to the products you specify.

To comply with the COM process, please follow these steps:

1. Select the COM material.
2. Check first with www.trenddealer.com/COM Library, to determine if this material has already passed testing for manufacturability on the intended product.
3. If the material is pre-approved in the COM Library, customer must submit a COM Guideline Form (available on www.trenddealer.com or from Trendway Customer Care Representative).
4. If the material requested is not in the COM Library, customer must submit a COM Request Form on-line at www.trenddealer.com, send a sample of the COM material (see Test Yardage Requirements below), and include a list of Trendway product numbers designated for the COM application. Material sample should include pattern name, pattern number and color, manufacturer, direction material should be applied, and Control number from the COM Request Form response.
5. Ship COM samples to:
 - U.S. Mail Shipment:
Customer Care
Trendway Corporation
P.O. Box 9016
Holland, MI 49422-9016
 - UPS, FedEx Shipment:
Customer Care
Trendway Corporation
13467 Quincy Street
Holland, MI 49424
6. You will be notified within five working days by Trendway, whether your COM has been approved or disapproved for application.

TEST YARDAGE REQUIREMENTS

Choices panels	1½ yd.
Flipper doors	2/3 yd.
Contrada tiles	1 yd.

NOTE: Most fabric houses have a yardage minimum or an upcharge on less than one-yard cuts.

NOTE: All COM applications are priced at Grade 1 or Grade A.

If Buyer desires to use his own material in the production of Trendway's products, it is necessary to obtain the prior written consent of Trendway. Material provided by the Buyer shall be shipped to seller, freight prepaid, and all risk of loss or damage shall remain with Buyer. Buyer must assume responsibility for any spoilage that takes place in the course

of processing or during transportation. Buyer hereby holds Trendway harmless against any and all claims for loss, liability, injury, or damage arising from use of customer material; and Buyer takes full responsibility for performance and quality of customer material. Buyer should also be aware that Buyer-furnished materials may not qualify for UL Listing or meet fire codes.

11a. Custom Color

Trendway's Custom Color program allows the customer to specify their own color or stain on many of Trendway's products. See www.trenddealer.com for product availability, individual product guidelines and lead times. Set up fees and lead times are product specific and will vary.

To request a Custom Color or Stain:

- Complete a Custom Color Request form (available on www.trenddealer.com).
- Send request form along with two 2"x3" samples to Trendway Customer Care Color Coordinator.
- After the receipt of the request, Trendway will provide customer with one color sample.
- If approved, Dealer or customer completes custom color form, providing the custom match color number on the back of the sample, signs, and returns by fax or mail to Custom Color Coordinator.
- Samples will be matched under cool white fluorescent lighting. All orders processed under the Custom Color program will be manufactured within commercially acceptable tolerances.
- Customer Color program is not available within Express lead-time.
- If applicable, dealer will be sent an invoice for \$200 color matching fee per customer, per color. See Custom Color Request form for details.

12. Special Product

When Trendway purchases special surface materials (i.e., fabrics and laminates) at the request of the customer, the customer takes full responsibility for the performance and quality of the surface material.

13. Delays

Trendway shall not be liable for loss or damage due to delay in manufacturing or delivery resulting from any cause beyond Trendway's reasonable control, including, but not limited to, compliance with any regulations, orders, or instructions of any Federal, State, or Municipal Government,

or any department or agency thereof, acts of God, acts or omissions of Buyer, acts of civil or military authority, fires, strikes, factory shutdowns or alterations, embargoes, war, riot, delays in transportation or inability due to causes beyond Trendway's reasonable control to obtain necessary labor, manufacturing facilities, or material from Trendway's usual sources. In no event shall Trendway be liable for special or consequential damages for any delay for any cause.

14. Postponement of Delivery

If unforeseen circumstances occur, Trendway Corporation may postpone delivery of ordered products. Customer will be notified when such postponement occurs.

15. Storage

When shipment is delayed by the Buyer, Trendway reserves the right to place the goods in storage at customer's risk and cost. Trendway charges $\frac{1}{4}$ of 1% of list price per week to cover storage. All terms and conditions of the sale, including but not limited to invoicing and payment, will continue as Buyer-specified destination; except that title remains with Trendway and that Trendway reserves the right to modify payment terms to assure recovery of any additional cost incurred.

16. Transportation

All orders shipped to any destination, within the contiguous United States, will be F.O.B. origin, freight prepaid, and risk of loss or damage shall pass to Buyer upon delivery to carrier. Trendway will determine the method and agency of transportation to be used.

Exceptions to standard prepaid freight are as follows:

- Customer directed expedites (Air Freight, Team Hauls) will be prepaid by Trendway and Customer will be billed the difference between standard and expedited freight.
- Truckload deliveries that are requested to deliver on weekends, Holidays or after 3:00 pm on Friday's will have an additional charge of \$450 per truck.
- Excessive unloading (in excess of 4 hours) will be billed at \$50 per hour after the initial 4 hour unloading period.
- LTL shipments normally deliver between 8:00 am and 5:00 pm, Monday through Friday. A specific delivery time on your assigned delivery date can be requested for an additional charge of \$150. This charge does not apply to full-truckload shipments. Requests for specific dates/times falling outside standard delivery timeframe for the

carrier serving your area constitute Expedites (see Customer-Directed Expedites, above). Expedite charges do apply to full-truckload shipments.

- Lift gate service will have an additional charge of \$85.
- Inside delivery service starts at \$50. Call Customer Care for quote.
- Reconsignment cost after shipment, starts at \$50. Call Customer Care for quote.
- Special equipment requirements call for a quote.

In the event that special F.O.B. Destination terms are agreed to by Trendway or delivery is made on Trendway-owned or -leased equipment, customer or authorized representative is responsible for noting any freight damage or shortage on the freight bill of lading at time of delivery and must notify Trendway within five (5) days of delivery day of any such damage or shortage. Assistance in a concealed damage claim on an F.O.B. Destination shipment will be provided by Trendway only if the product has been immediately unpacked and both the carrier and Trendway have been promptly notified of resultant damage so the proper inspection can be made.

Shipping Note:

Trendway strives to minimize packaging to help the environment and to make installations faster and cleaner.

Trendway ships products in using various packaging methods based upon the product type and shipping method (full truck vs. LTL), all of which are designed to provide protection for the product while minimizing packaging materials.

Trendway test packaging designs to ensure their effectiveness.

17. Product Ownership

Title and risk of loss to all goods sold shall pass to Buyer upon Trendway's delivery to Buyer or to a carrier at shipping point. Trendway, however, retains the Purchase Money Security Interest in all goods shipped and the right to perfect same.

18. Damaged Materials

Trendway Corporation is not responsible for shipped products when the common carrier is in receipt of the material. Trendway expects all customers to thoroughly inspect orders on receipt regardless of point of delivery. Clear receipt should not be given on the material until it has been checked for damage in transit. All claims for noted damaged material must be made by the customer to Trendway Customer Care.

Concealed damage or damage not noted at time of delivery shall be made by the customer to the common carrier within 15 days after receipt. Trendway assumes no liability for such damage.

19. Shortage on Order

Shortage on ordered products must be reported to Trendway Corporation within five (5) days of product delivery and must be noted on bill of lading at time of delivery.

20. Product Usage and Compliance

Buyer assumes full responsibility for the application of Trendway's product to Buyer's use, and compliance with Trendway installation and maintenance instructions and reasonable load restrictions. Compliance to local code restrictions regarding fire, electrical, and building codes are the responsibility of the customer or his authorized agent.

21. Post-Delivery Assistance

Installation and servicing of Trendway products are normally handled directly by Trendway-authorized dealers. When this is not possible, assistance is available by calling Trendway's Customer Care Department, Holland, Michigan.

22. Returned Goods

As a basic policy, Trendway does not accept returned material, because most items are manufactured per order and are not in stock at the factory. If material is authorized for return because of Trendway error, shipment may be made freight collect. Any other goods for which Trendway does authorize a return will be sent prepaid and a restocking charge of 35% will apply. **To receive authorization to return goods, please contact Trendway's Customer Care Department.**

All Returned Materials Authorizations expire thirty (30) days from date of issue. Any product returned after 30 days will be refused and returned to sender collect.

Electrical components, nonstandard items, Express products, and fabric-covered goods may not be returned. Replacement products will be billed to you with credit being issued upon return of the product in good condition. All goods returned must be in the original Trendway packing cartons. Goods will be inspected for damage upon return. No credit will be issued for goods which are damaged. **As a general statement of policy, return authorization will not be issued for items unless they are Trendway stock items.**

23. Special Marking or Tagging

Special tagging is available on all orders free of charge. Trendway suggests this option to simplify the staging and installation of product. **Tag designations must be specified at the time an order is placed.**

Limited Lifetime Warranty

Trendway Corporation warrants to the original purchaser that the products described in its price lists, sold after August 1, 2004 will be free from defects in materials and workmanship commencing with the date of initial purchase and continuing for as long as the original owner uses these products. This warranty provides limits on the following products:

	Systems	TrendWall	Seating
10 Year	Electrical Components Systems		
5 Year	Drawer Slides Systems Textiles Finishes Electronic Ballasts	System Textiles Finishes	Jet, Live and Live II Seating Snap, In and Prelude Guest Seating
3 Year	Veneer Magnetic Ballasts		Trim Surface Trends Foam Arm Pads
2 Year	Surface Trends	Surface Trends	
1 Year	Non-Standard Product Personal Task Lighting	Non-Standard Product	Non-Standard Product
Not Covered	Light Bulbs Customer's Own Material	Customer's Own Material	Customer's Own Material

The following exceptions apply to all product lines:

- The Trendway warranty applies to normal three shift office use, with the exception of seating. Seating is warranted for single-shift usage with a maximum weight limit of 300 lb., with the following exceptions rated to a 250 lb. weight limit: Snap #1 Seat Slider & Aluminum Base Options, Sketch R #1 Seat Slider Option, Code Stools, Stat Chairs, Sketch F & M Chairs.
- Damage caused by improper treatment of the product including exposure to unusual environmental conditions (extreme climates, acids, and moisture)

This comprehensive warranty applies to all products installed by a Trendway authorized installer. Trendway will repair, or at its option, replace defective merchandise, free of charge, which, when used normally and pursuant to Trendway's published instructions, and applicable planning guide information, prove to be defective within the period stated. This remedy is expressly agreed to be exclusive as a condition of sale. No person is authorized to assume for Trendway any warranty liability, except as expressly set forth in this paragraph, or set forth in writing by an authorized officer of the company at its headquarters in Holland, Michigan.

Any and all labor charge backs must be pre-approved by Trendway's Customer Care Manager in writing.

This warranty does not apply to damage resulting from accident, alteration, transport, or misuse, as well as damage from normal wear and tear such as dents, nicks, scratches, fading and improper maintenance. Trendway employs quality measures to ensure color consistency in our products. However, due to the effects of light and other environmental factors, no guarantee can be made for an exact match to product in an existing installation.

Natural variations occurring in materials such as wood and leather are not considered defects, and Trendway does not warrant the matching of colors, grains, textures or colorfastness of these materials.

Trendway provides a three-year warranty on veneer products for quality and craftsmanship. Due to the natural properties of wood, the following are not covered under this warranty:

- Changes in wood color resulting from exposure to light or aging
- Natural color variation between wood veneer and solid wood pieces
- Natural color variation resulting from veneer lay-up
- Natural variation in wood grain or the presence of character marks
- Normal wear and tear
- Exact matching to swatch cards

Trendway makes no warranty to purchasers who acquire products for personal, family, or household purposes, or to purchasers acquiring the product other than directly from Trendway Corporation, its authorized dealers, or others who are specifically authorized by Trendway to sell such products. Trendway's liability with respect to its products shall not exceed that expressly set forth above irrespective of the theory upon which a claim might be based, including negligence. Under no circumstances shall Trendway be liable for incidental or consequential damages. Original product label must be attached to the product in question.

The warranty period is not interrupted or prolonged by the performance of a service under the terms of the warranty. There are no other warranties except as expressly set forth above, either express or implied, including any warranty of design, merchantability or fitness for any purpose.

This warranty supersedes all previously printed Trendway warranties.



CORPORATE CENTER
LEARNING CENTER
CHICAGO CENTER
ATLANTA CENTER
WASHINGTON CENTER
LOS ANGELES CENTER

13467 Quincy Street | PO Box 9016 | Holland, MI | 49422-9016 | P 616 399 3900 | Trendway.com
43 E. 8th Street | Suite 250 | Holland, MI | 49423 | P 616 399 3900
325 N. Wells Street | Chicago, IL | 60610 | P 312 661 1808
3525 Piedmont Road NE | 8 Piedmont Center | Suite 210 | Atlanta, GA | 30305 | P 404 995 1630
1201 New York Avenue NW | Suite 280 | Washington, DC | 20005 | P 202 408 7430
1933 S. Broadway | Suite 126 | Los Angeles, CA | 90007 | P 866 576 3134